

SCHNITTMUSTER FÜR JERSEY-SHIRT

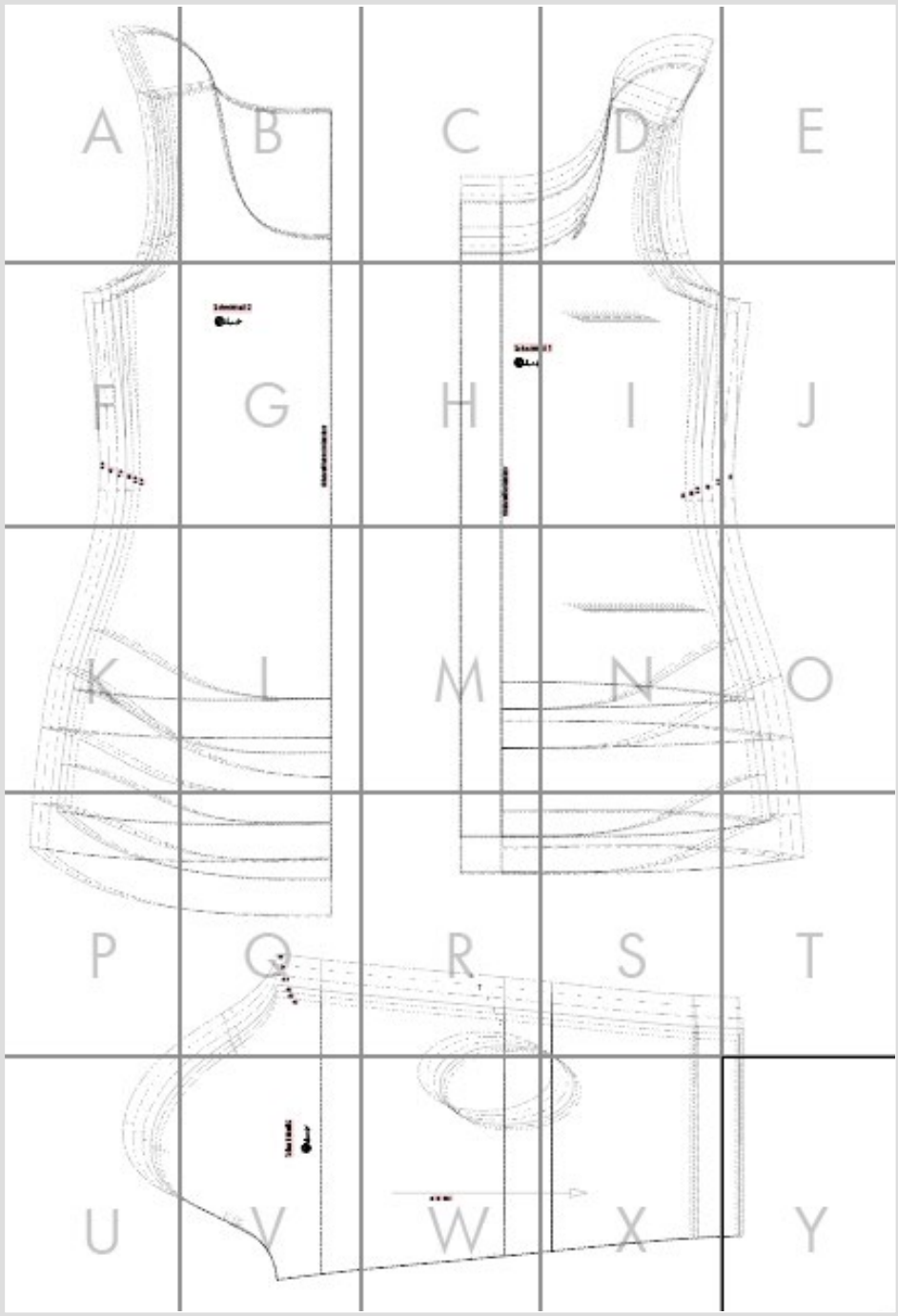

A

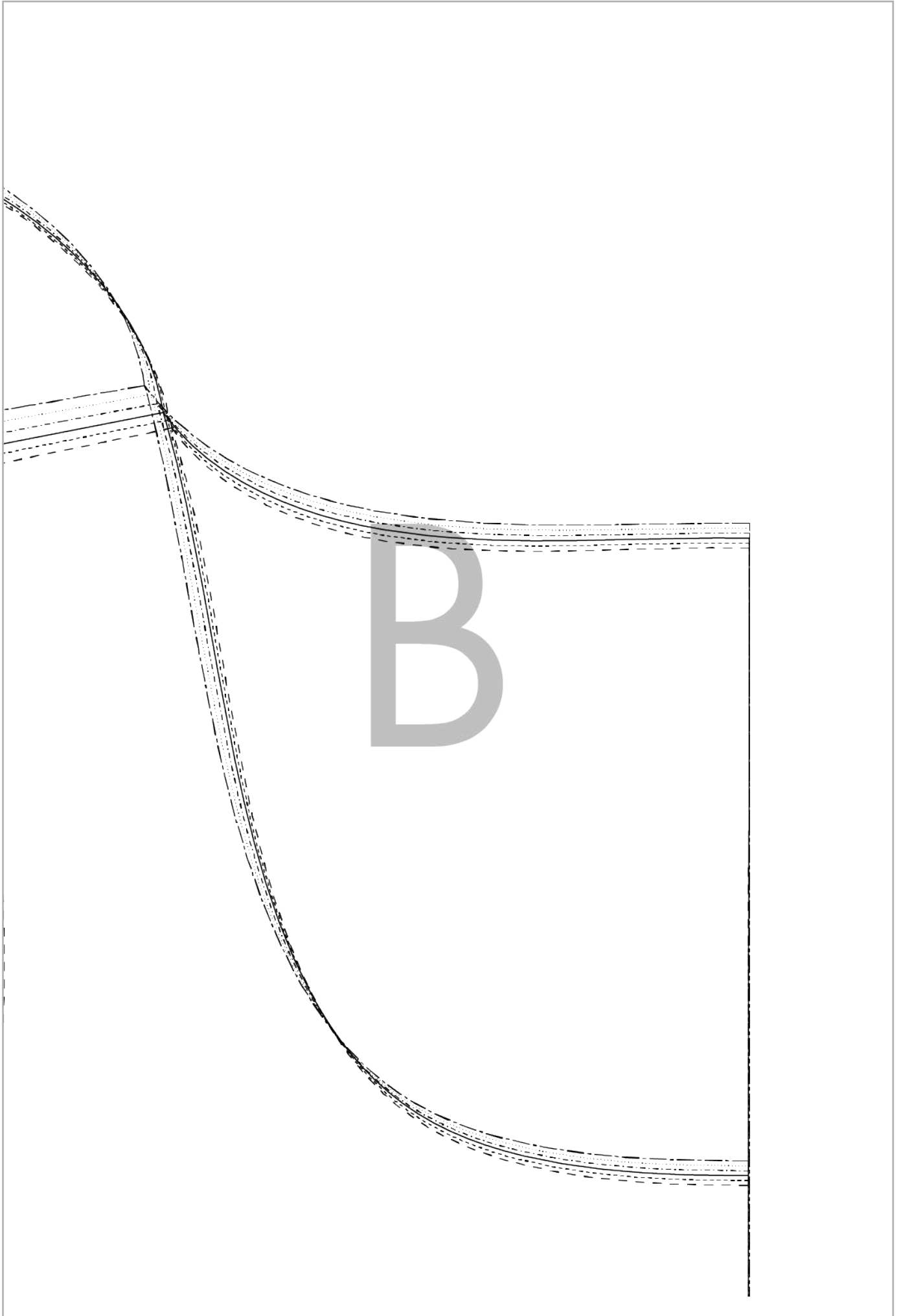



C

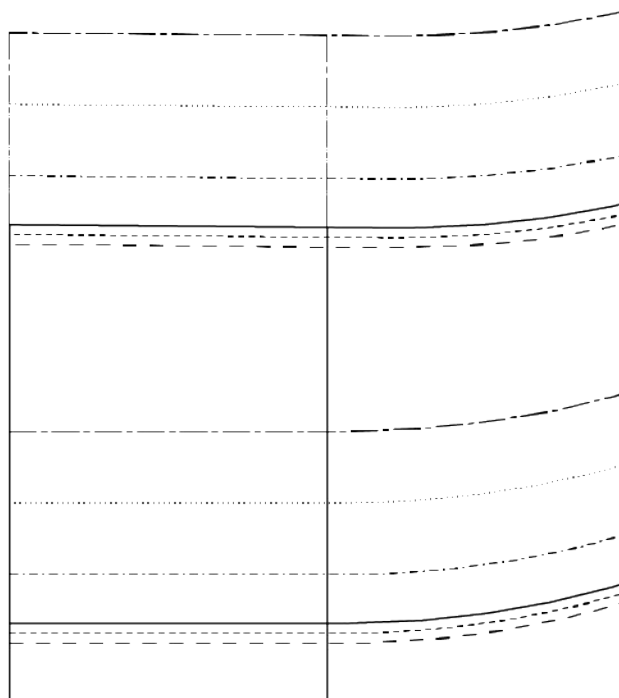

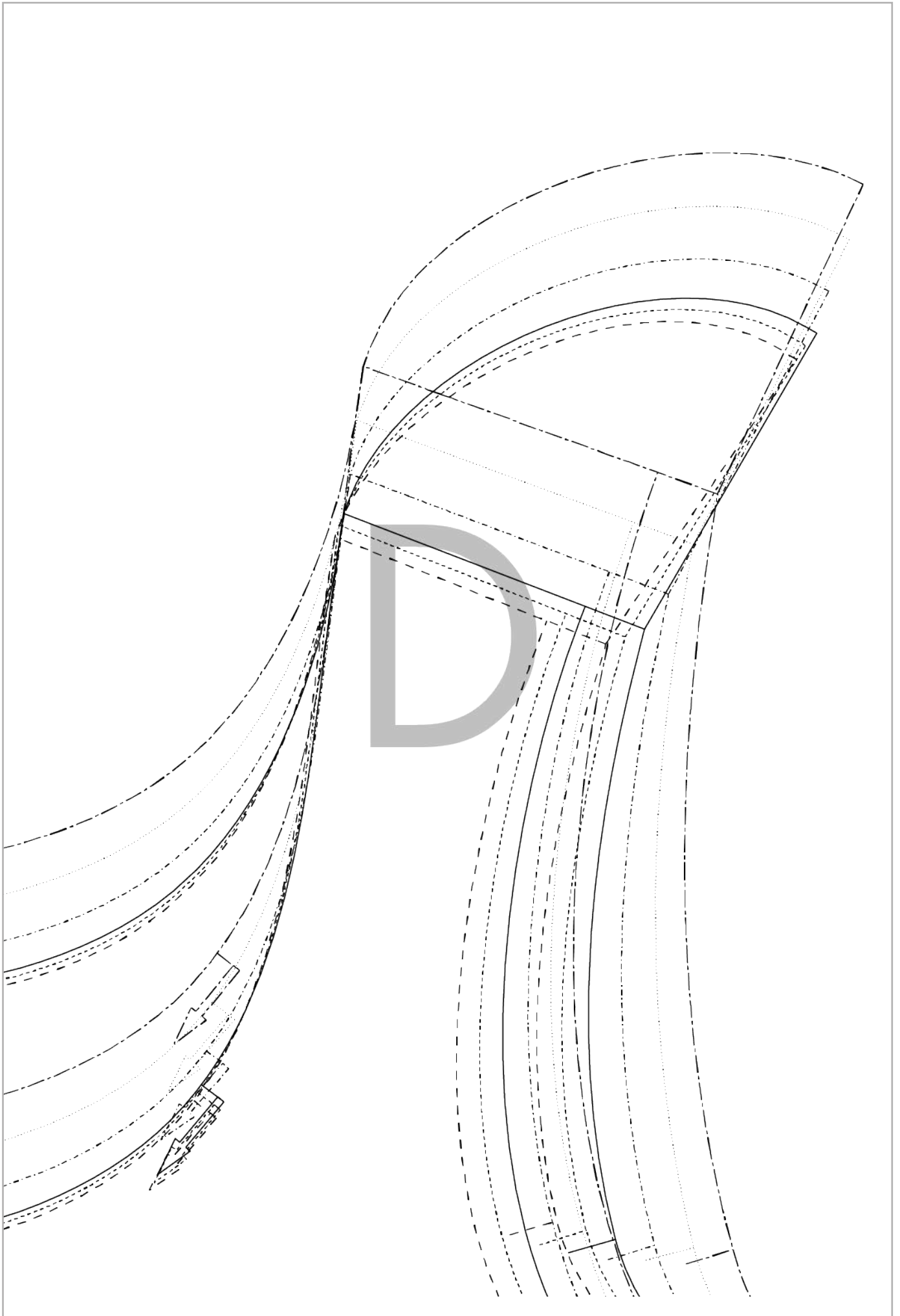

E

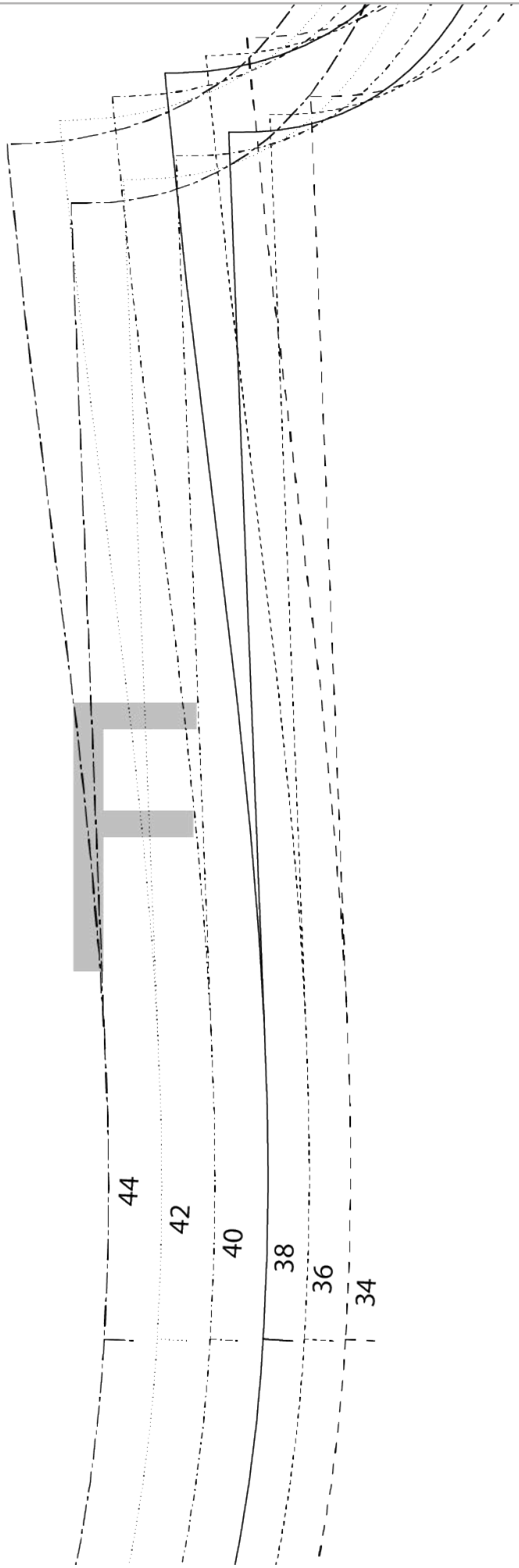

Schnittteil 2



G

hintere Mitte/Bruch/Fadenlauf

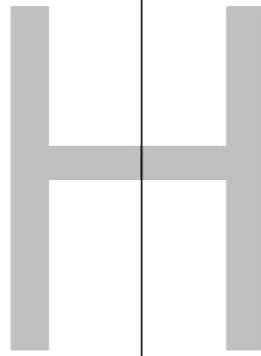

vordere Mitte/Fadenlauf

Schnittt



il 1

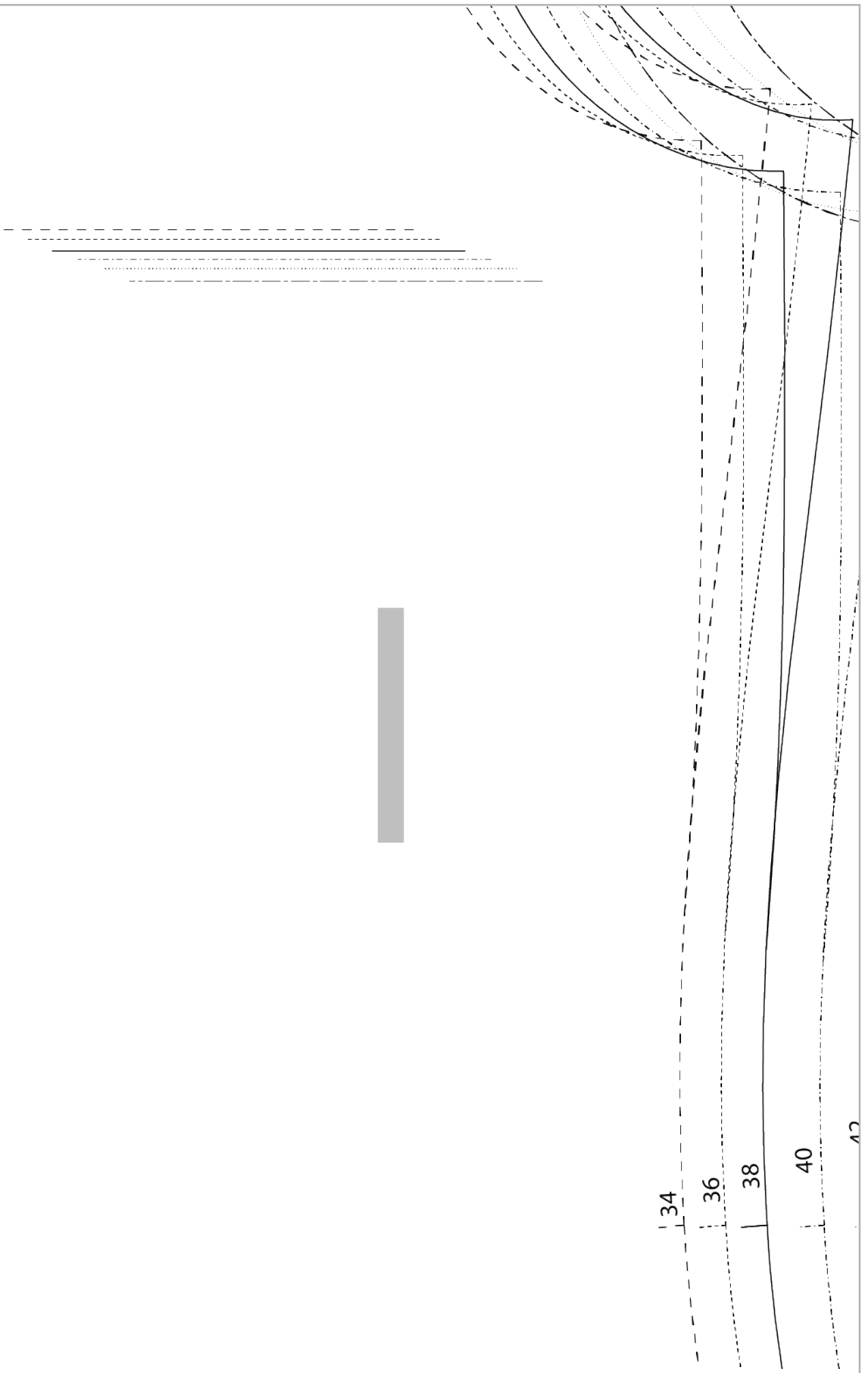

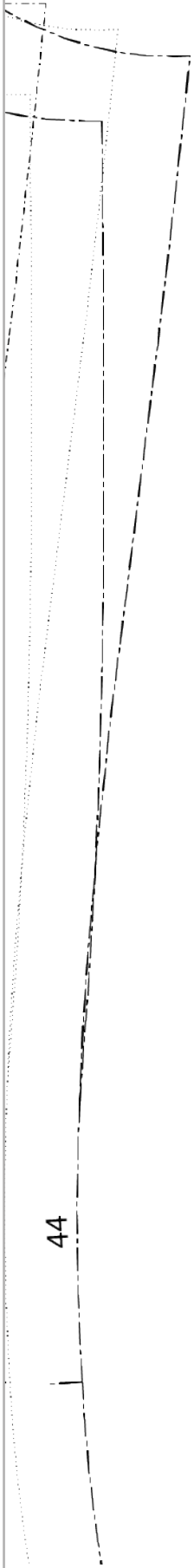

J

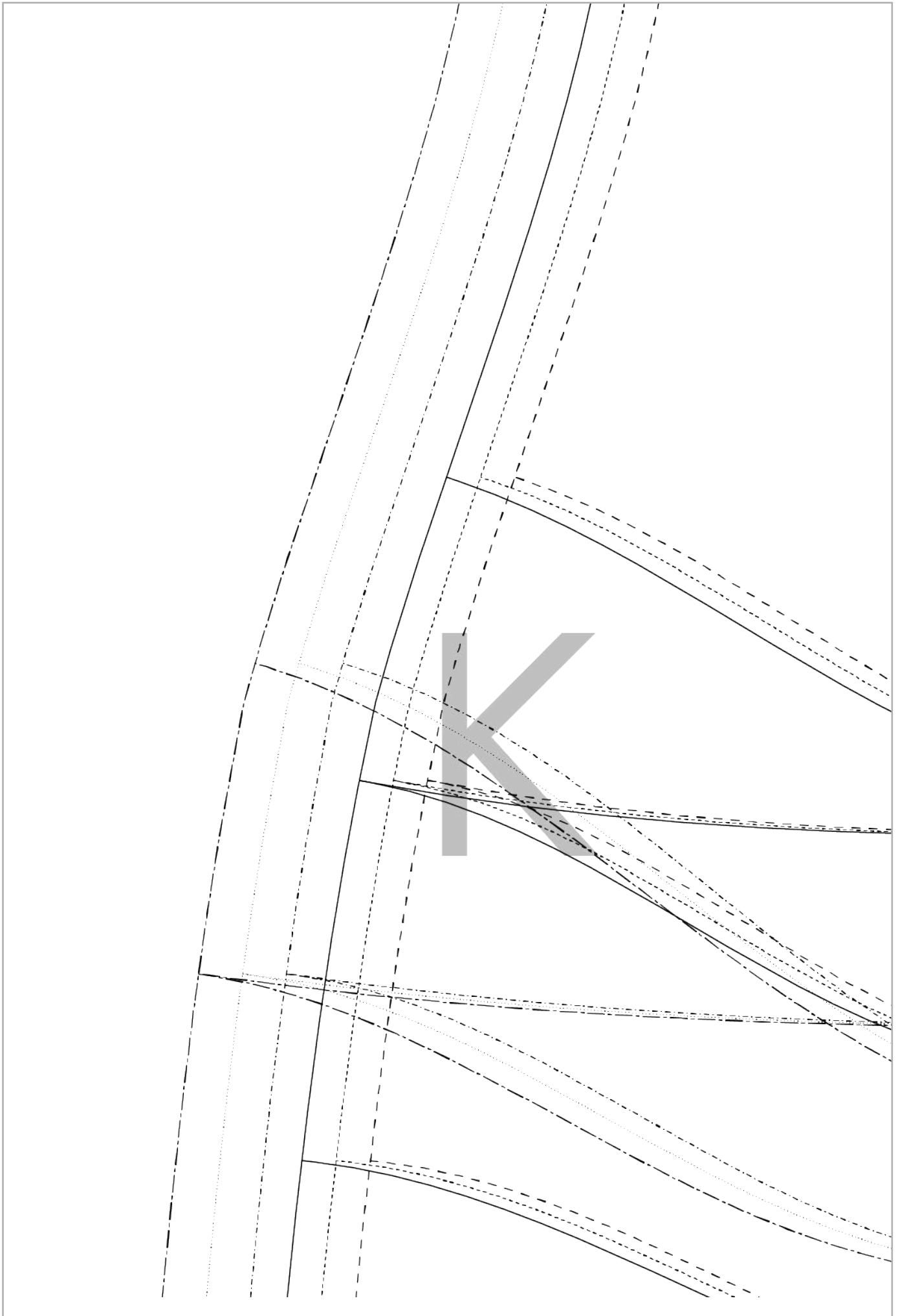

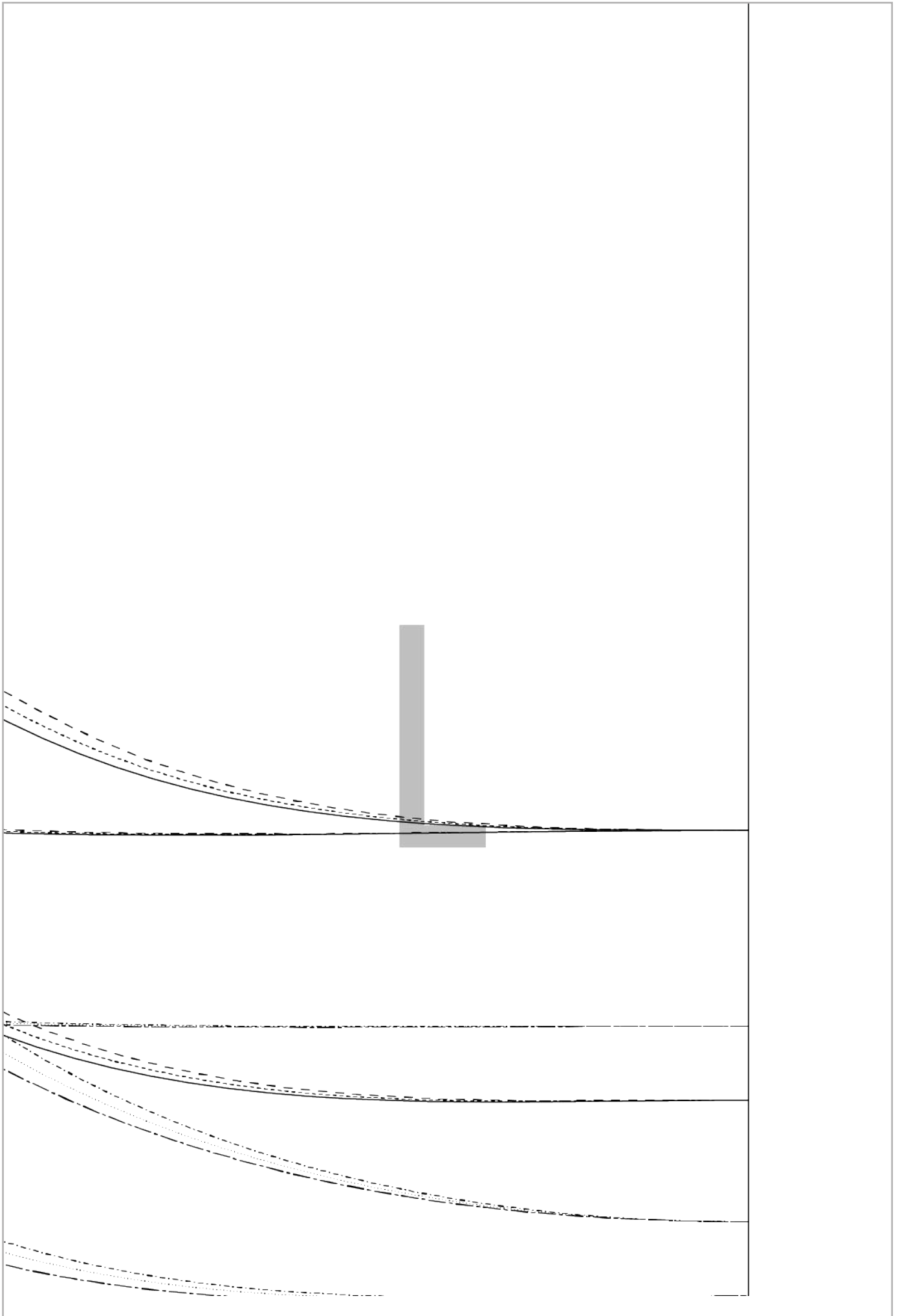

M M

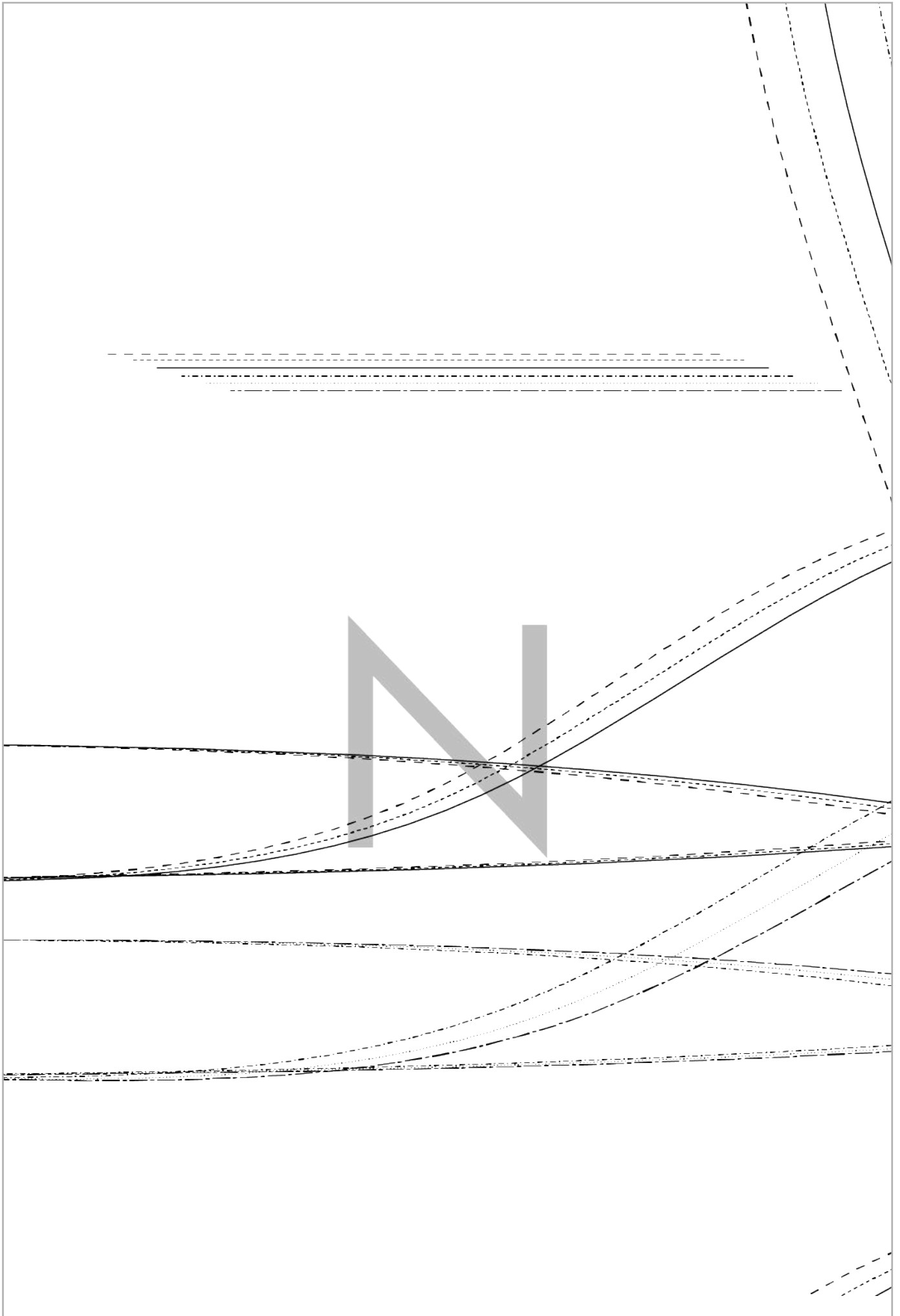

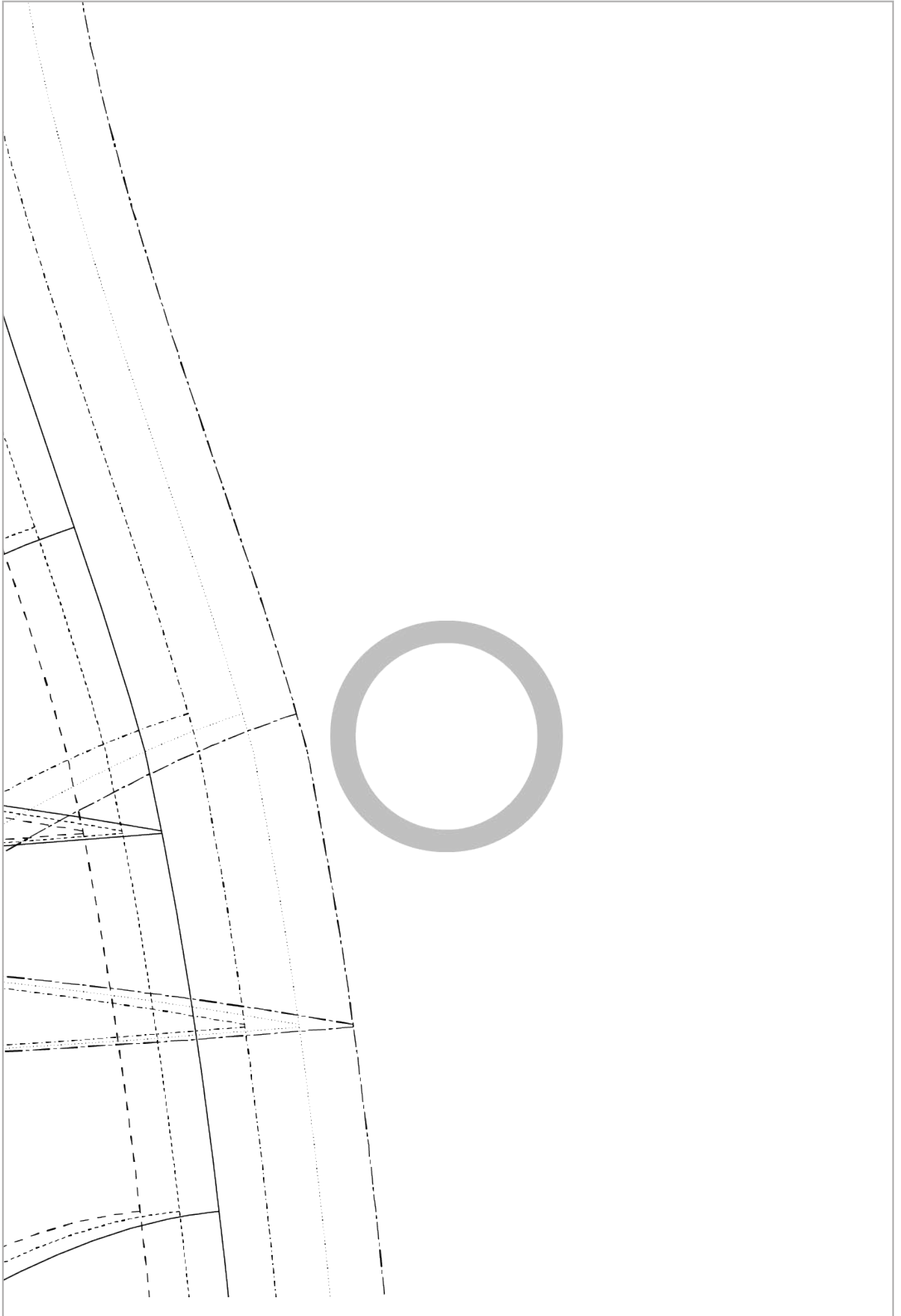

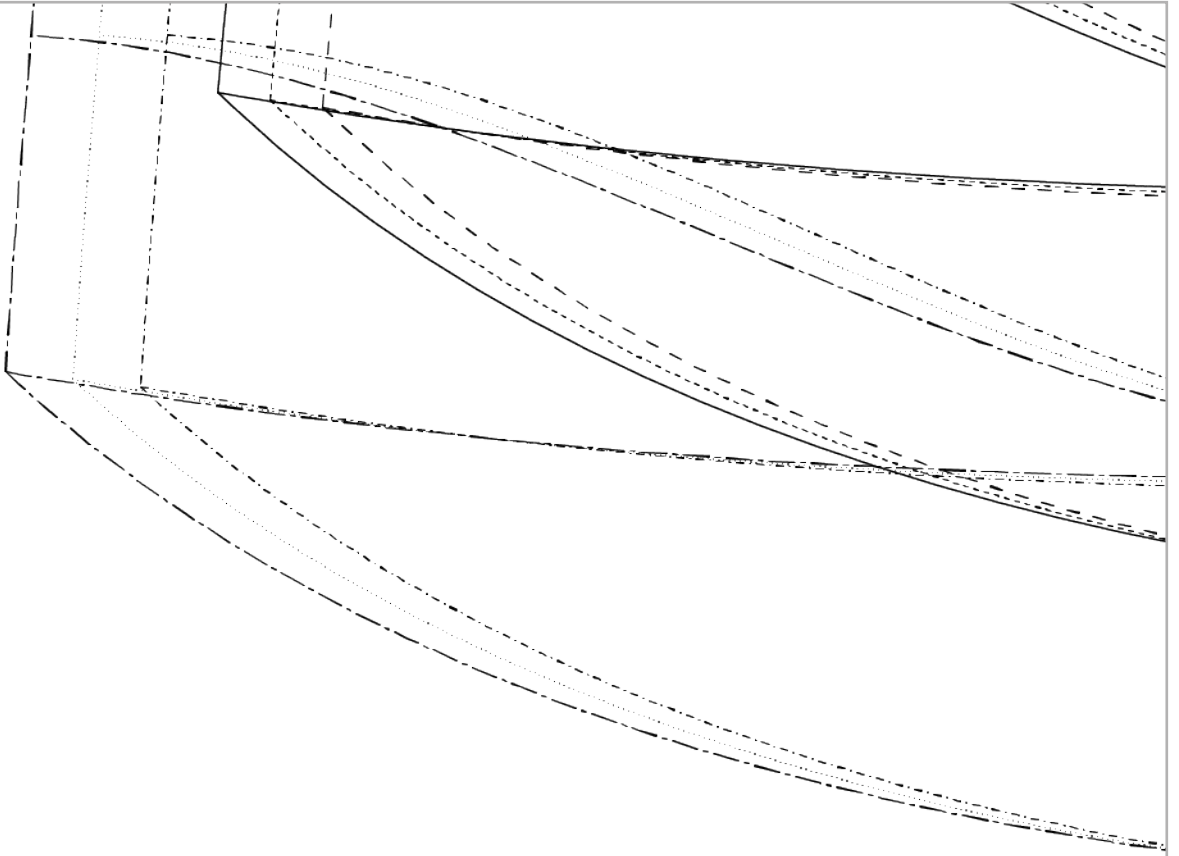

P

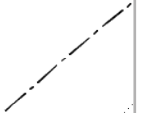

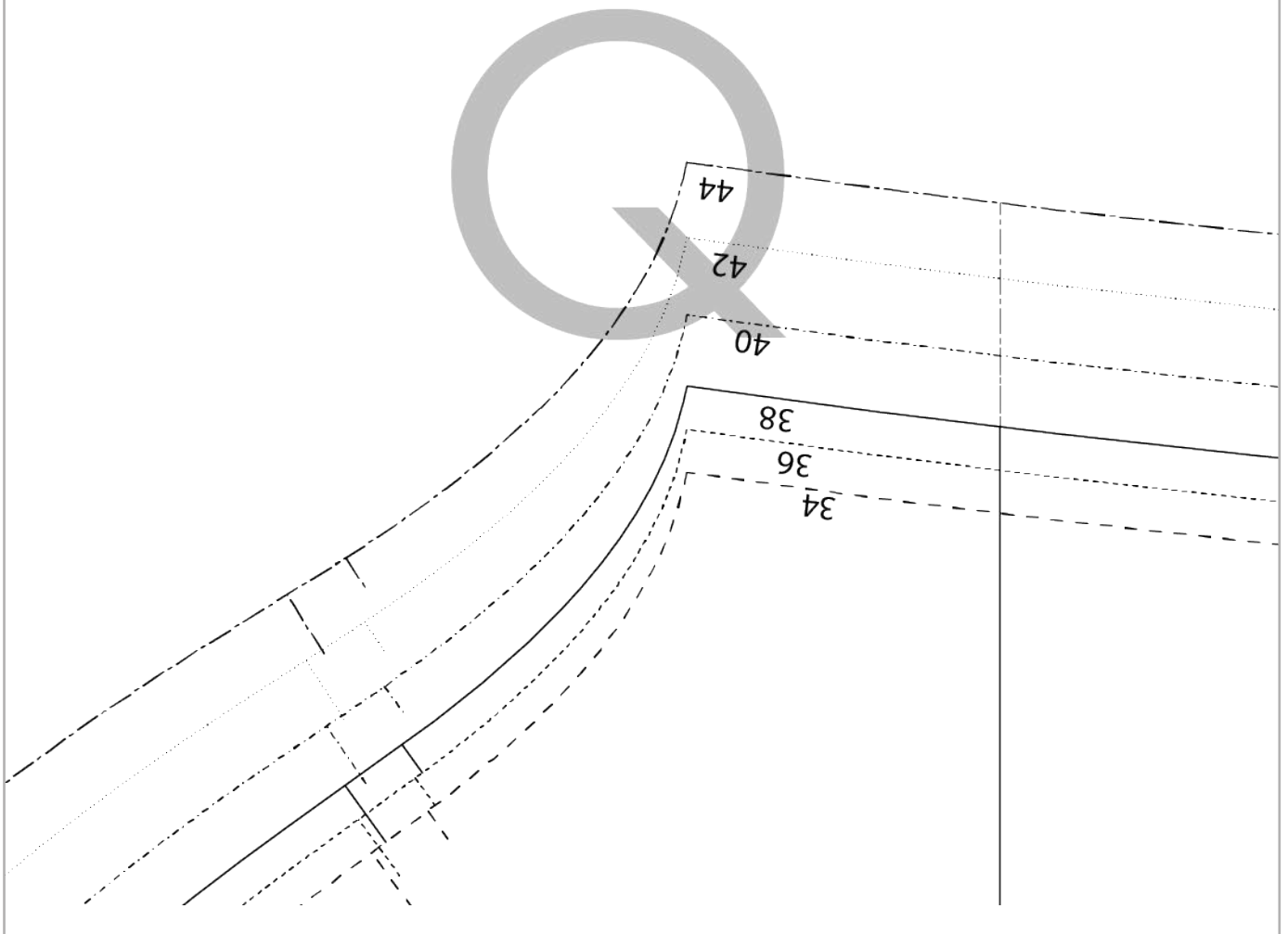
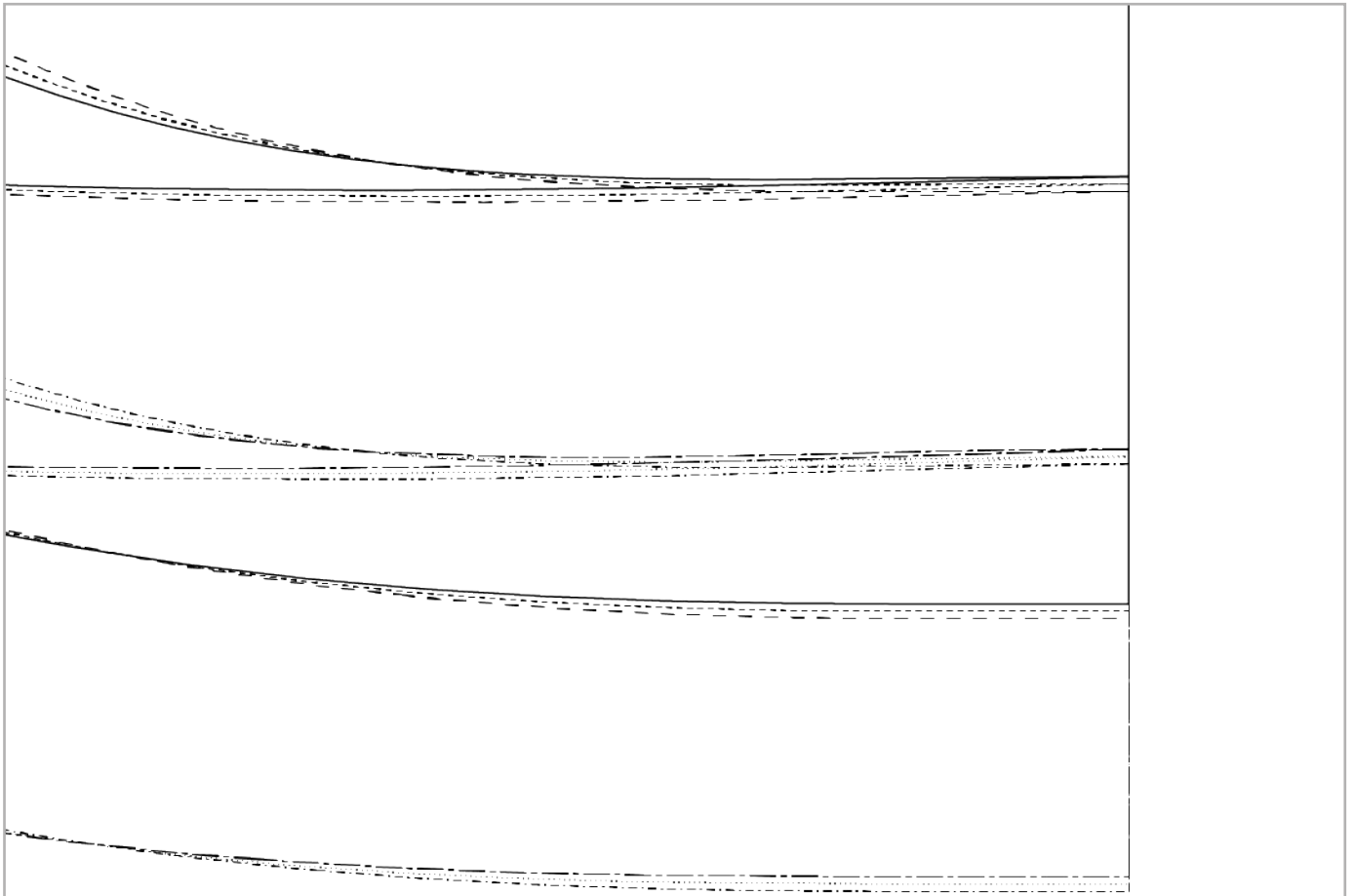

R

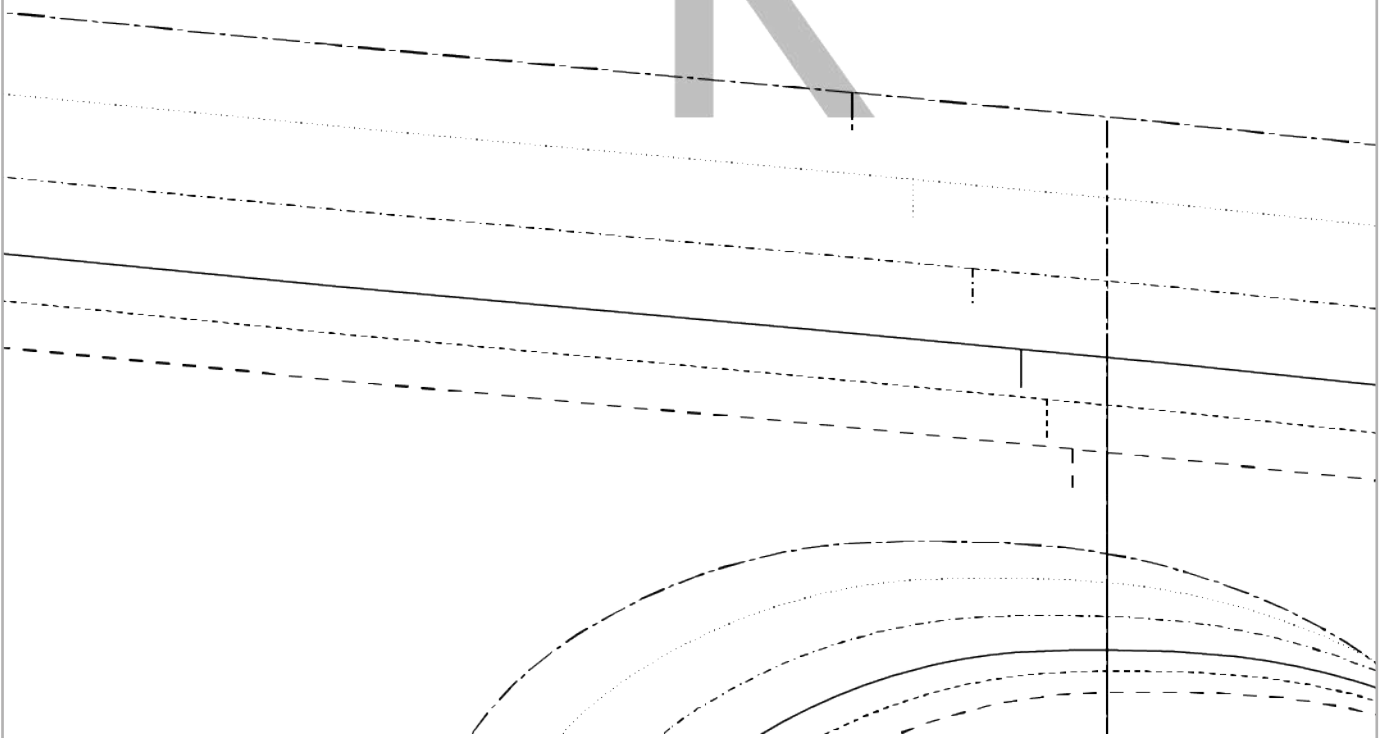

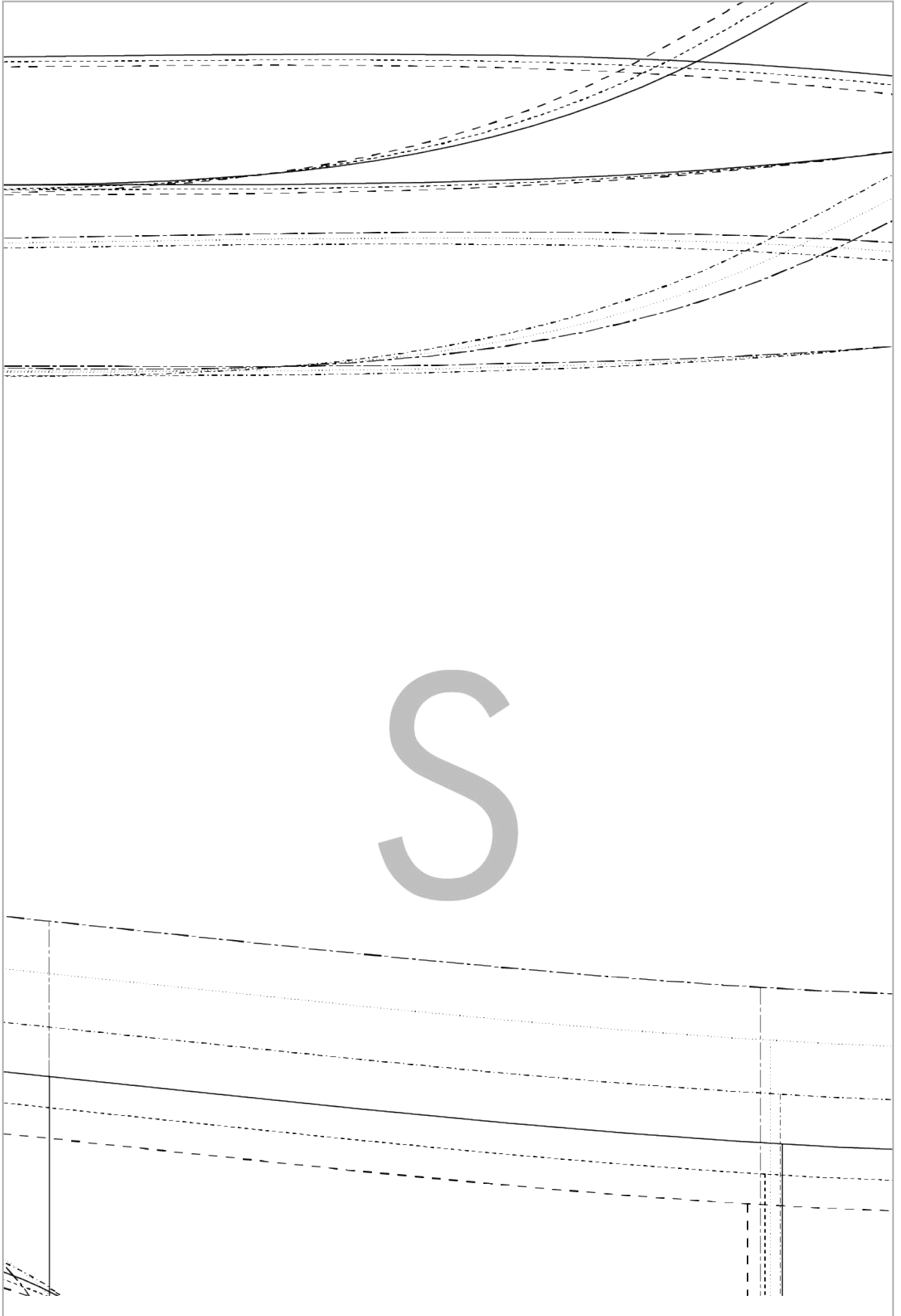

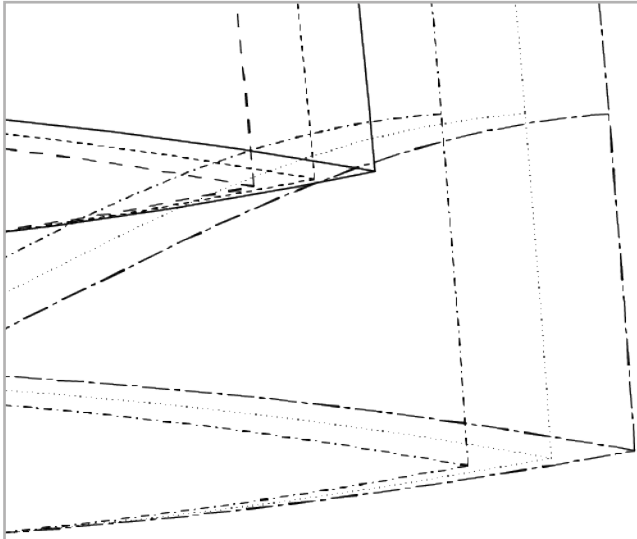

T

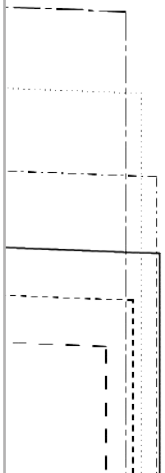

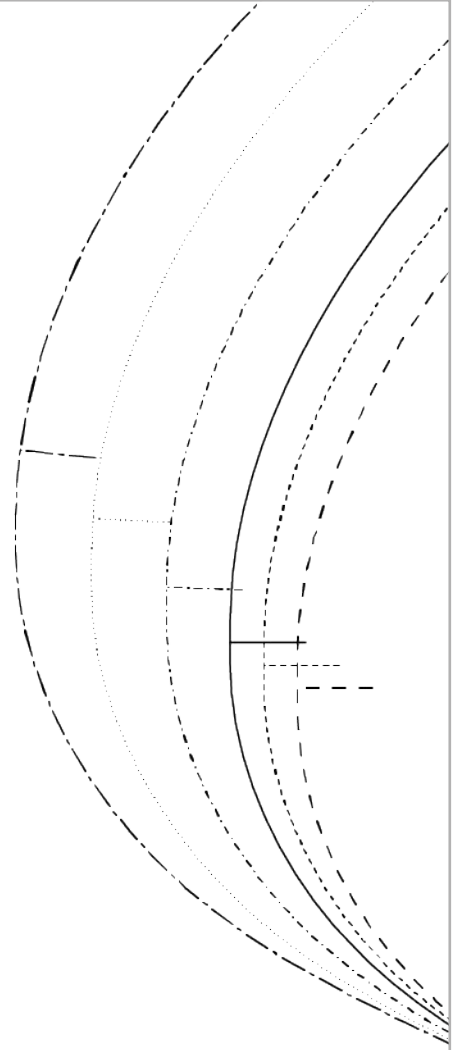

U



Schnittteil 6

Makerist

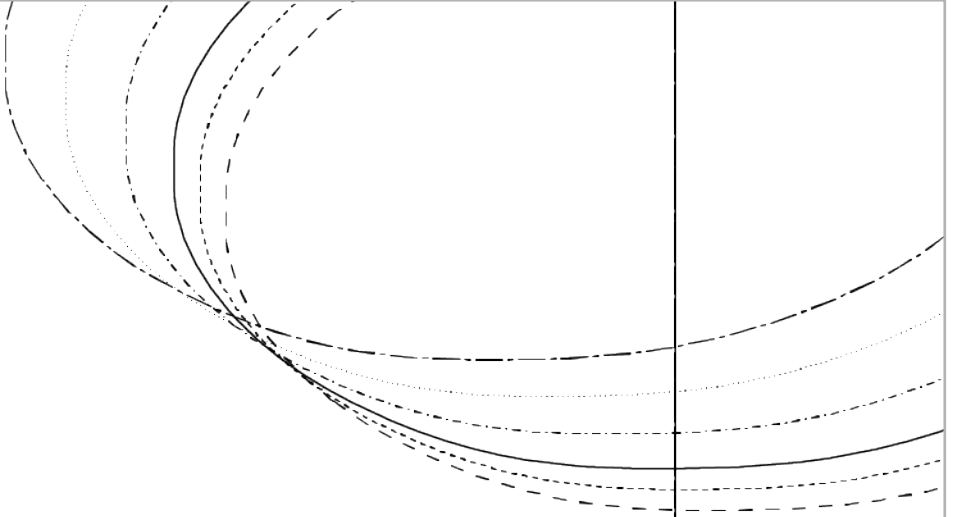

Fadenlauf

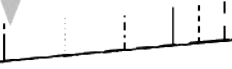

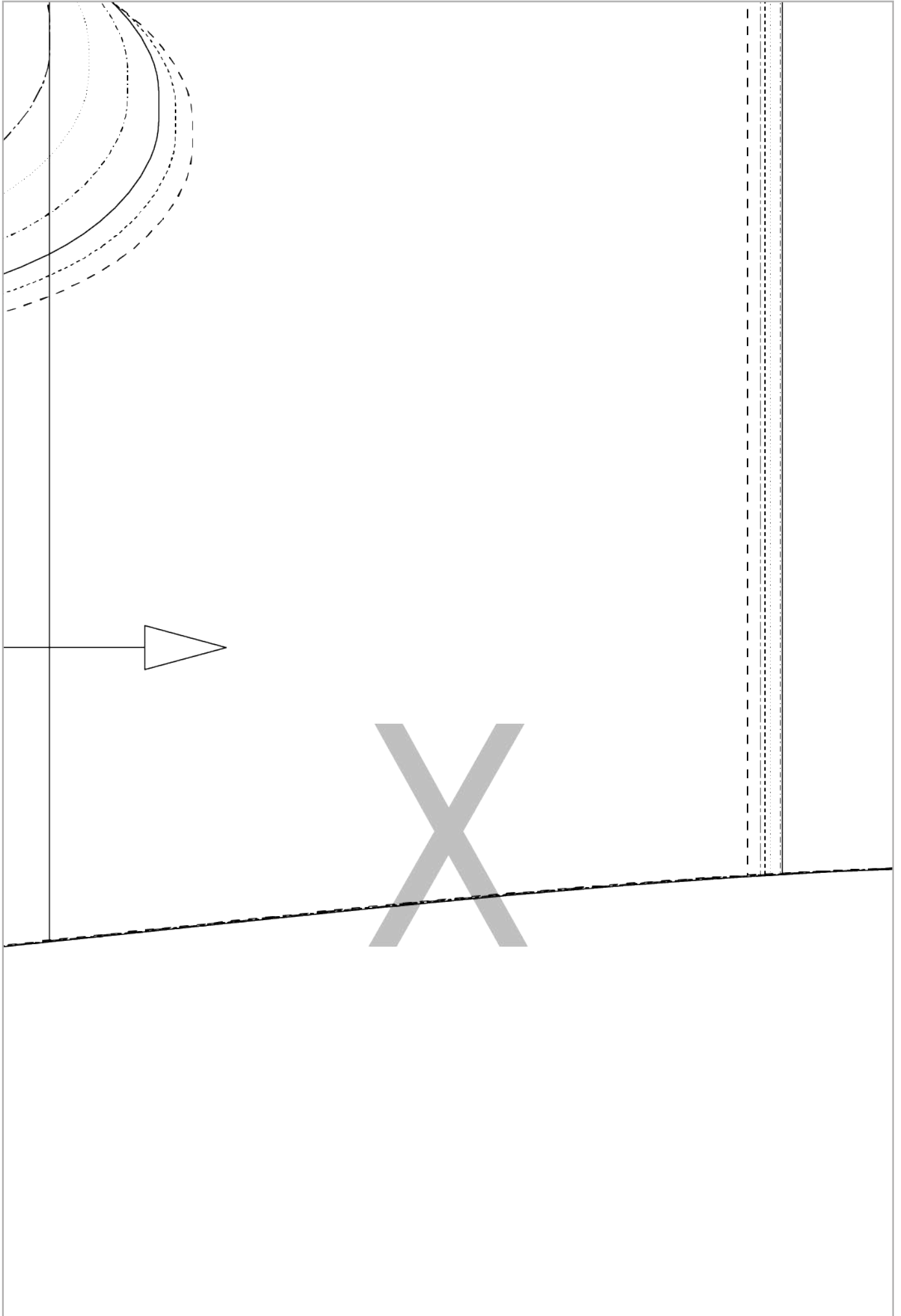



Y